

SPAR-Marathon

ROOFING SUPPLIES

Aluminum Coil	56
Bathroom Vent	40
Breathers	41-42
Copper Eavestrough	53
Copper Roof Drains	43-47
Copper Sheet	38
Drains & Accessories ...	40-49, 51-52
Eavestrough & Accessories ...	53-57
Flashings	36-37
Hoppers	40
Lead Coated Copper	36, 38
Lead Sheet	52
Metal Roofing & Siding	58-59
Moss & Mildew Preventor	38
Muriatic Acid	54
Pitch Boxes	39
Plugs	52
Plywood Clips	50
Rain Caps	40
Roof Anchors	50
Roof Deck	52
Scuppers	40
Seal Tape	48
Solder & Accessories	54
Stack Base	41
Steel Roofing	58-59
Strainers	48
Tall Cones	39
Vandal Proof Vents	41

PICKERING, ON
(905) **426-4443**

TORONTO, ON
(416) **534-8421**

WESTON RD (WESTON)
(416) **745-4111**

SIGNET DR (WESTON)
(416) **744-2050**

Custom Sheet Metal Products

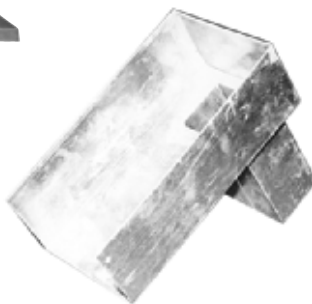
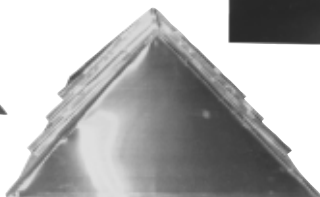
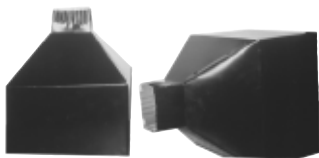
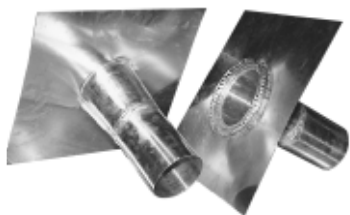
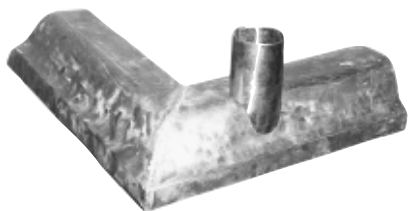

We custom make to your measurements flashings, drains, scuppers, cones, eavestrough products, collector boxes, tapered metal, caps and covers, etc., etc., out of galvanized pre-painted, copper, lead-coated copper, or aluminum.

Custom Sheet Metal Products

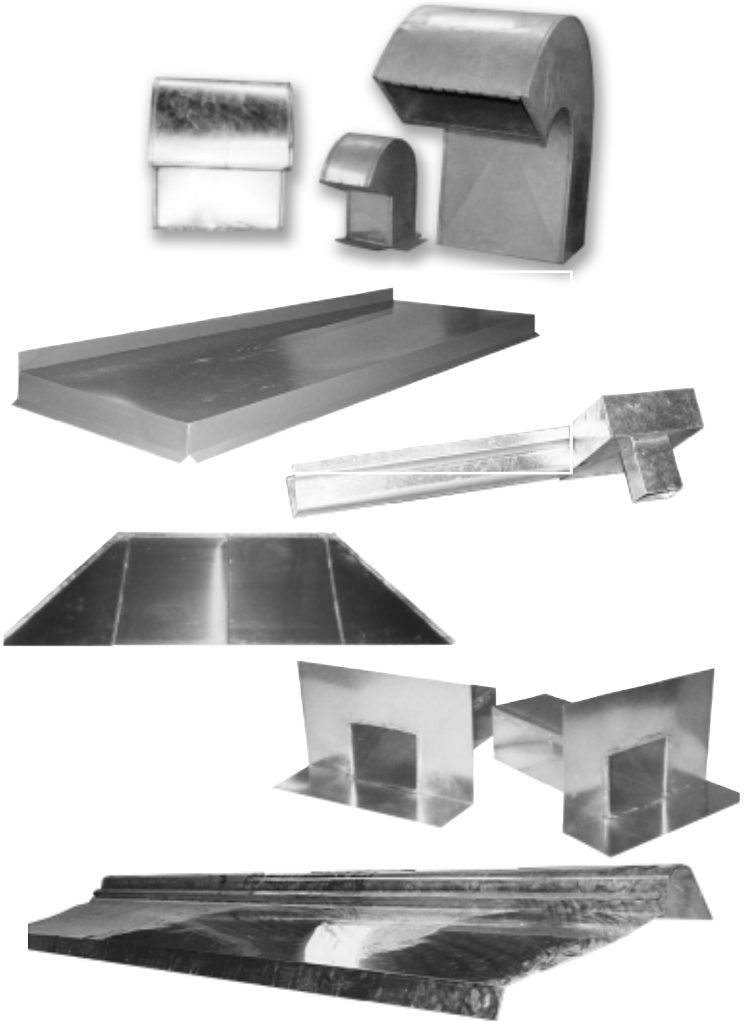

CALGARY, AB
(403) **255-8236**

EDMONTON, AB
(780) **432-2786**

WINNIPEG, MB
(204) **338-7613**

Custom Sheet Metal Products

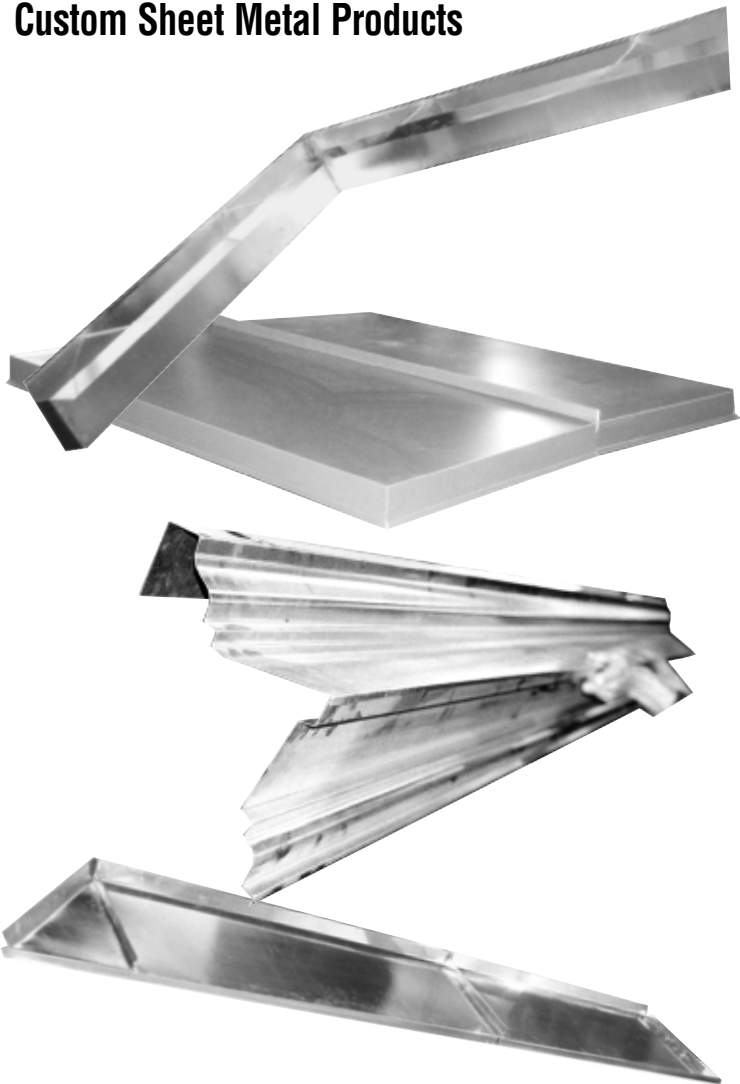

Complete Metal Fabricating Including:

Bending, Cut to Size, Computerized Plasma Cutting, Painting, Auto CAD Design, Metal Working and Machining, Metal Rolling, Sheet Metal Services, Custom Fabrication, etc., etc.



SERVICE IS OUR SPECIALTY • SPAR-Marathon

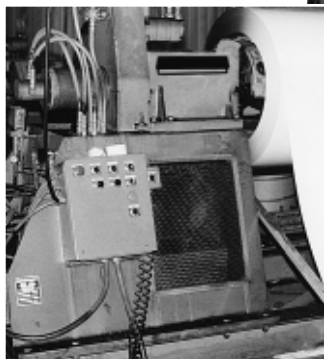

PICKERING, ON
(905) **426-4443**

TORONTO, ON
(416) **534-8421**

WESTON RD (WESTON)
(416) **745-4111**

SIGNET DR (WESTON)
(416) **744-2050**



OAKVILLE, ON
(905) **825-0034**

LONDON, ON
(519) **668-3626**

HAMILTON, ON
(905) **560-2858**

BARRIE, ON
(705) **792-6683**

Stock Metal Flashings

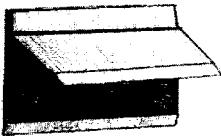

Gravel Stop

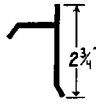

6"
Regular



7-1/2"
Large

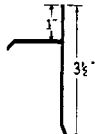

7"
High

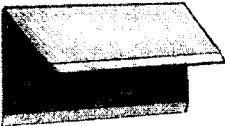

Drip Edge

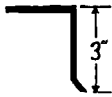

6"
Regular

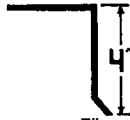

7"
Large



4"
Window

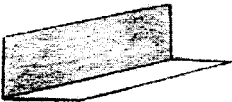

Step Flashing

(available in several sizes)



Stock Metal Flashings

Available in:

- Galvanized and Pre-Painted colours

Custom Flashing

- Made to order
- Available to your exact measurements
- Any quantity
- Galvanized, Copper, Lead Coated Copper or over 15 colours are stocked
- Variety of gauges
- We will cut sheets into any size strips, up to 48"

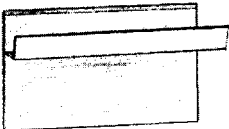

Starter Strip

(economy starter strip also available)

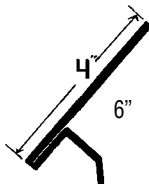

Cant Flashing

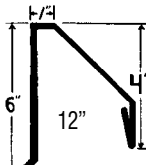

Stock Metal Flashings

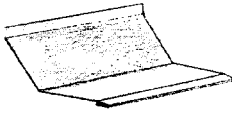

Wall Flashing

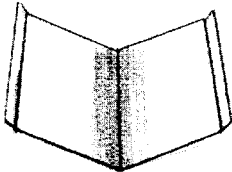
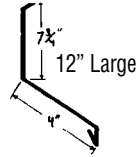
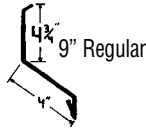

Valley

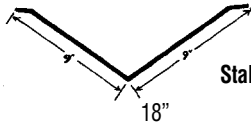

Stabilizing Bend for Easy Handling

Also available in 24"

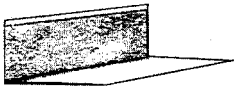

Chimney (Flu) Pans



Available in Single, Double, or Extra Large

Available as pan only or Complete Unit, with side and back pieces

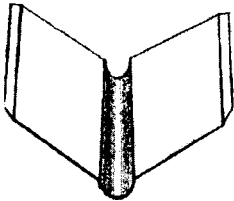

Ridge Roll

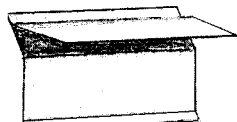
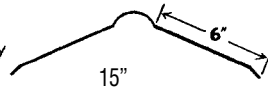
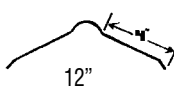

Gravel Stop for Shingle

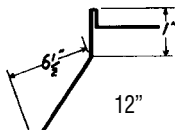

Sheet Metal

Sheet Sizes:

36" x 96"

36" x 120"

48" x 96"

48" x 120"

We will shear sheets to your specific measurements.

Sheet Metal

We stock sheets, and coils and mini coils in the following:

- galvanized
- pre-painted
- copper
- lead coated copper
- mill aluminum
- pre-painted aluminum
- a variety of gauges and sizes



Zinc, Moss and Mildew Preventer

Apply zinc strip to both sides of ridge cap. Rain will release zinc, killing moss, mildew and algae. For shingle, shake or tile roofs.

Available in 40' x 2-1/2" rolls.

Chimney Pans

- galvanized or pre-painted
- wide variety of sizes and colours
- available as a pan only or complete with flashing accessories

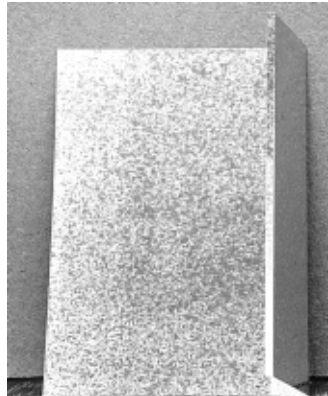

Tall Cones

- for Pitch or Flat Roofs
- strong galvanized construction
- collars available for exact fit
- wide variety of sizes stocked
- custom sizes available

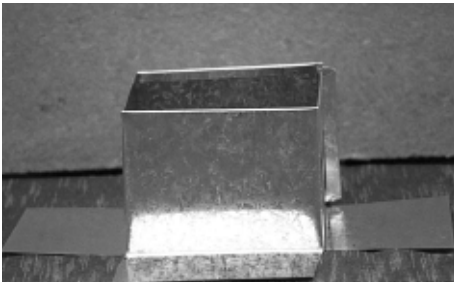
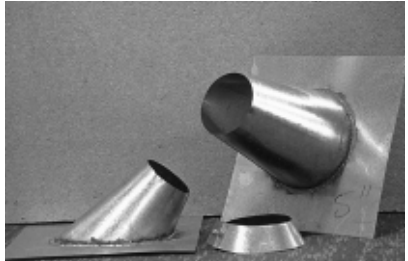

Galvanized Pitch Pans

- available in one standard size
- custom sizes available

Pre-Primed Pitch Pans

- available in a variety of stock sizes or custom made
- base and sides are pre-primed
- base has filled in corners to provide complete square base
- opens up for easy wrap around installation

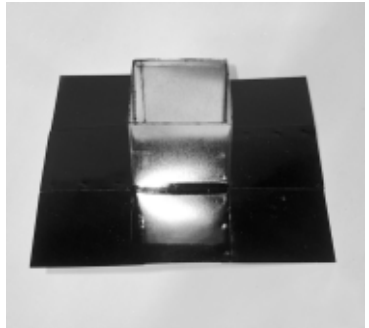

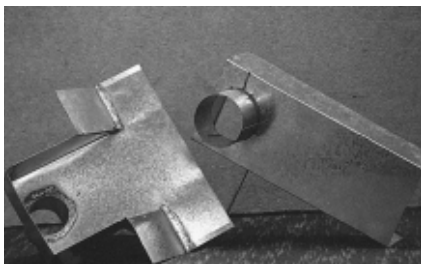

Regular Scuppers and Cant Scuppers

- galvanized construction
- water-tight solder
- 3" and 4" stocked
- custom sizes available
- available in short or long versions

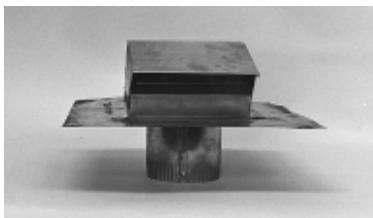

#5951 Bathroom Vent

- low profile and compact design
- used for mobile homes, venting for fan exhaust and weather-proofing exhaust pipes
- built in flapper keeps out insects and birds and eliminates the need for screens
- 4" pipe attachment

Rain Caps

- stocked in a variety of standard sizes
- custom sizes available

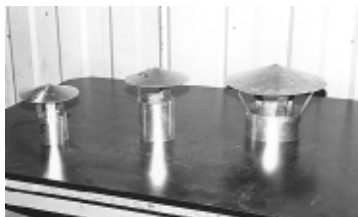

Aluminum Hoppers

- spun aluminum roof drains in 3" & 4"
- your most economical choice for drainage
- available with ring and standard strainer or eavestrough style wire strainer insert
- can also be used as a pitch pan



SPAR-Marathon Vent Stack Flashings are used to ensure a waterproof seal between the roof membrane and the vent stack pipe. They are recognized as good insurance on roofs prone to large degrees of movement of the roof deck.



Stack Base and Cap

- spun from one piece of heavy gauge aluminum without welded seams that might leak
- simple and easy to install
- telescoping action of 3" or 4" vent stack caps allows for roof deck movement
- hub will accommodate insulation for prevention of condensating moisture on inner pipe
- wide flashing flange promotes ease of installation and greater adhesion area
- stack will accommodate a maximum 16" (407 mm) and minimum 9" (282 mm) existing pipe height

Non-insulated Stack Breather

- can be used as a stack flashing or breather
- vandal proof – no removable parts
- spun from one piece heavy gauge aluminum (no seams to leak)
- 1" perforated holes for maximum air flow
- will accommodate up to 6" diameter pipe



Insulated Stack Breather

- same design as non-insulated stack breather
- includes insulation for prevention of condensation
- will accommodate up to 4-1/2" diameter pipe



SPAR-Marathon

SPAR-Marathon insulation breathers and vents are used to prevent moisture vapour from becoming trapped in the roofing system. They are recognized as good insurance against blistering, cracking and crazing (alligating) of membrane, while helping to maintain thermal design efficiency.

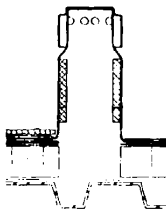

Aluminum Insulvent I (one way)

- low cost, all metal breather used for venting all types of insulation
- spun from heavy gauge aluminum
- an extra wide 4" base opening and securely attached cap
- one-way valve design prevents moisture from re-entering the roofing system
- unique vandal proof cap design shields against entry of windblown rain or snow
- recommended spacing: 1 per 1000 sq ft

Options



Foam Insert

- prevents moisture from condensing on the inside of the standpipe

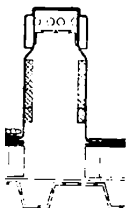

One Way Valve Insert

- our exclusive one way valve insert is a small disk that allows the breather to be only a one way breather. (breathes out but not in)

SPAR-Marathon

Copper Roof Drains



The result of years of experience and development, **SPAR-Marathon** Copper Roof Drains provide the most versatile, quality copper drains for virtually any application, from new roof construction, re-roofing and maintenance.

They are economical, durable and easy to install. They can be joined quickly to any drain pipe and will bond securely to any roof membrane, cutting time and costs on installation and ensuring long, trouble-free service.

SPAR-Marathon Copper Roof Drains can be custom fabricated so that special requirements, restrictions or tolerances may be met. Optional flange coatings that will allow the drain to meet varied membrane attachment applications can also be provided. **SPAR-Marathon** can also provide connectors for fitting the copper drains to existing conductor pipe.

Whatever your roof drain application, **SPAR-Marathon** Copper Roof Drains will fill the requirements ... saving time, reducing costs and giving performance satisfaction.

Our exclusive Perforated Ring ensures proper water flow down the drain.

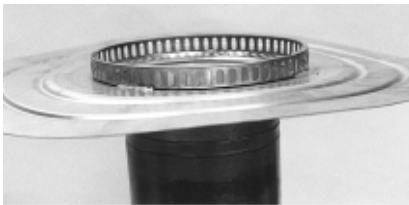

Other manufacturers need a buildup of water before overflowing above their rings; the result is often improper water flow or ponding.

The **SPAR-Marathon** ring also securely locks the strainer in place, providing a superior roof drain system.

SPAR-Marathon Perforated Ring

SERVICE IS OUR SPECIALTY • SPAR-Marathon

SPAR-Marathon

Copper Roof Drains

Funnel Type 1820F



Long life drains consist of an 18" diameter, 20 oz. (0.27) spun copper flange, with slight corrugations, soldered to a seamless copper pipe. The flange is coated with a bituminous paint to ensure a good bond with the roof membrane. May be specified unpainted for use with generic materials other than asphalt.

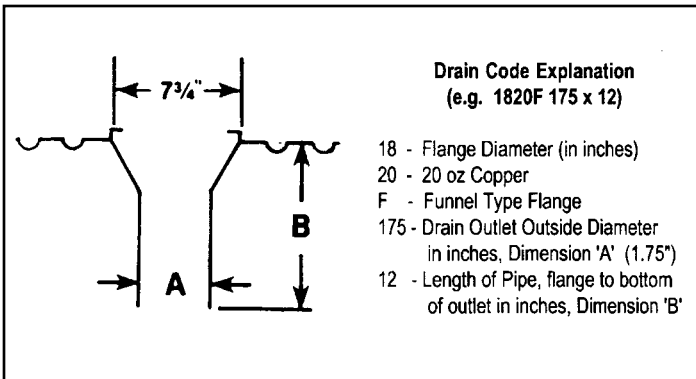

SPAR-Marathon

Funnel Type 1820F - 75 Series (3/4")

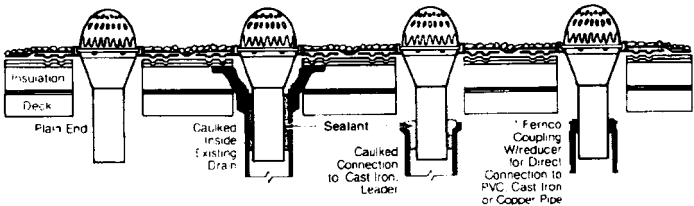

Specs Flange, Size, Pipe Depth	A Outlet Drain	B Flange to bottom of pipe	Fits Inside of Drain Pipe Size	Strainer Size	Sump or Deck Opening	Weight (lbs)
1820F 175 X 12	1 3/4"	12"	2"	8"	8"	3 1/4
1820F 275 X 12	2 3/4"	12"	3"	8"	8"	3 1/2
1820F 375 X 12	3 3/4"	12"	4"	8"	8"	4 1/4
1820F 575 X 12	5 3/4"	12"	6"	8"	8"	6
1820F 175 X 18	1 3/4"	18"	2"	8"	8"	3 1/2
1820F 275 X 18	2 3/4"	18"	3"	8"	8"	3 3/4
1820F 375 X 18	3 3/4"	18"	4"	8"	8"	5 1/4
1820F 575 X 18	5 3/4"	18"	6"	8"	8"	9

Funnel Type 1820F - 100 Series

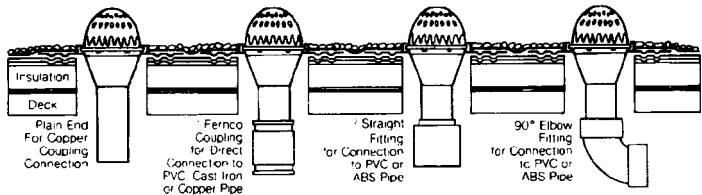

Specs Flange, Size, Pipe Depth	A Outlet Drain	B Flange to bottom of pipe	Fits Inside of Drain Pipe Size	Strainer Size	Sump or Deck Opening	Weight (lbs)
1820F 200 X 12	2-1/8"	12"	2"	8"	8"	3 1/2
1820F 300 X 12	3-1/8"	12"	3"	8"	8"	4
1820F 400 X 12	4-1/8"	12"	4"	8"	8"	5
1820F 600 X 12	6-1/8"	12"	6"	8"	8"	7-3/4
1820F 200 X 18	2-1/8"	18"	2"	8"	8"	4
1820F 300 X 18	3-1/8"	18"	3"	8"	8"	4-3/4
1820F 400 X 18	4-1/8"	18"	4"	8"	8"	5-3/4
1820F 600 X 18	6-1/8"	18"	6"	8"	8"	11-1/4

SPAR-Marathon

Copper Roof Drains

Straight Type 1416S

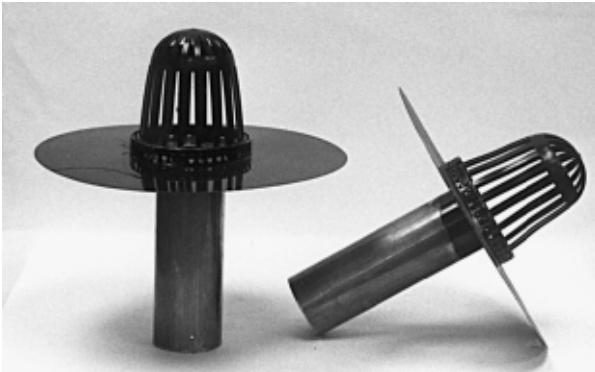

Long life drains consist of an 14" diameter, 16 oz. (0.22) spun copper flange, with slight corrugations, soldered to a seamless copper pipe. The flange is coated with a bituminous paint to ensure a good bond with the roof membrane. May be specified unpainted for use with generic materials other than asphalt.

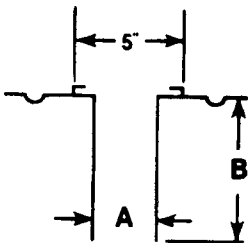

**Drain Code Explanation
(e.g. 1416S 200 x 9)**

- 14 - Flange Diameter (in inches)
- 16 - 16 oz Copper
- S - Straight Type Flange
- 200 - Drain Outlet Outside Diameter in inches, Dimension 'A' (2.00")
- 9 - Length of Pipe, flange to bottom of outlet in inches, Dimension 'B'

SPAR-Marathon

Straight Type 1416S - 75 Series (3/4")

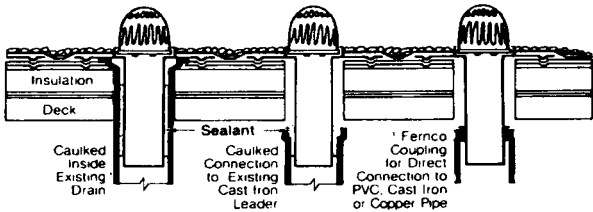

Specs Flange, Size, Pipe Depth	A Outlet Drain	B Flange to bottom of pipe	Fits Inside of Drain Pipe Size	Strainer Size	Sump or Deck Opening	Weight (lbs)
1416S 275 x 9	2-3/4"	9"	3"	5"	4"	3-1/4
1416S 375 x 9	3-3/4"	9"	4"	5"	5"	2-3/4
1416S 175 x 15	1-3/4"	15"	2"	5"	3"	2-1/4
1416S 275 x 15	2-3/4"	15"	3"	5"	4"	3-1/2
1416S 375 x 15	3-3/4"	15"	4"	5"	5"	3-3/4

Straight Type 1416S - 100 Series

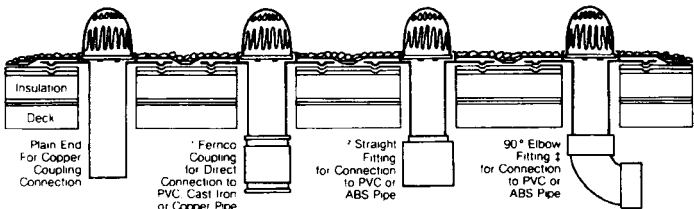

Specs Flange, Size, Pipe Depth	A Outlet Drain	B Flange to bottom of pipe	Fits Inside of Drain Pipe Size	Strainer Size	Sump or Deck Opening	Weight (lbs)
1416S 300 x 9	3-1/8"	9"	3"	5"	3-1/2	3-1/4
1416S 400 x 9	4-1/8"	9"	4"	5"	3-3/4	2-3/4
1416S 200 x 15	2-1/8"	15"	2"	5"	2-1/2	2-1/4
1416S 300 x 15	3-1/8"	15"	3"	5"	4-1/4	3-1/2
1416S 400 x 15	4-1/8"	15"	4"	5"	4-3/4	3-3/4

Beehive Strainers

- this proven design has years of usage
- 8" for funnel type drains and 5" for straight type
- available in cast aluminum and plastic



Aluminum



Plastic



Drain Sealant Tape

- ensures a long lasting watertight seal
- the tape is a high density, elastic foam impregnated with modified asphalt
- the tape is compressed to approx. 25% of it's uncompressed dimensions



Instructions

- cut tape to desired length
- peel off release liner and wrap around drain stem and insert drain quickly
- tape expands to create a seal against water back up

Available in 1-1/4" x 4 m rolls
or we can pre-install it on drain



RD Series Aluminum Roof Drains

Available in the following configurations:

RD 28 - Funnel-type 3" - 6" diam.

RD 28 RR - Retrofit, funnel type 2.75" - 5.75" diam. (optional EPDM Super Seal available)

RD 29 - Straight-type 3"- 6" diam.

All Thaler Drains include plastic strainers (optional cast aluminum strainers available). Available in Aluminum, Copper, or Stainless Steel

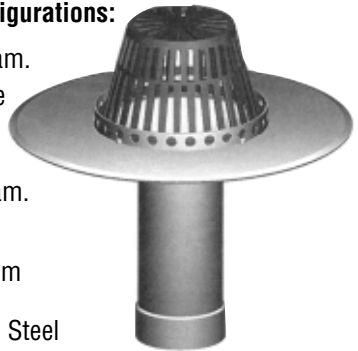

RDX30-A-RR RETROFIT ROOF DRAIN (Aluminum, Funnel Type Outlet)

The Thaler RDX30-A-RR Super-Seal Roof Drain consists of a vandalproof cast aluminum strainer, aluminum strainer retainer, membrane compression unit, deck flange with funnel type straight aluminum outlet. Ideal drain for BUR, EPDM, TPO & SBS where a membrane Clamping Ring is desired;

Available to receive a Super Seal or "U" Flow.

Sizes for Retrofit 1.75"-2.75"-3.75"-4.75"-5.75"

Sizes for New Work 2.00"-3.00"-4.00"-5.00"-6.00"

EPDM Super Seal

(for use with RD 28 RR Drains)

Available in 3" - 6" diam.



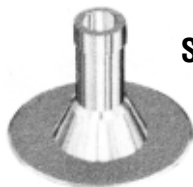

SJ-20 Insulated Stack Jack Flashing

Available in 2" - 6" & 8" diam. sizes.



BASE w/ C-212 Cap

Portals Plus Alumi-Flash

Due to the flexibility of the EPDM rubber caps, roof leaks are eliminated because penetrations are allowed to expand, contract and vibrate independently of the waterproofing.

SELECT A CAP



C-126
1-2" TO 4" PIPE



C-412
4-1" TO 2" PIPES



C-481
4-3/8" TO 1" PIPES



C-212
2-3/8" TO 1" PIPES
2-1" TO 2" PIPES



C-182
1-8" TO 12" PIPE

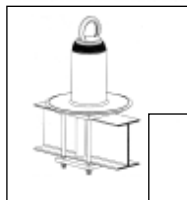

Fall Arrest Roof Anchors

Available in a wide variety of configurations to meet individual requirements.

Please fax or call us with your job specifications.

Plywood Clip

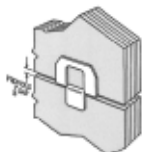

- installs between plywood panels
- provides 1/8" gap between sheets and straight, flush spacing
- available in 3/8" and 1/2"



PC/Pet Retro Drain

- Provides a mechanical watertight thermoplastic seal
- Quick and easy installation
- PC/Pet material is not altered by roof top chemicals
- Available in 3", 4", 5" and 6" sizes



Superdome Retro Drain

- Heavy duty version of PC-Pet retro drain
- Compatible with all roof types
- Allows roof top maintenance without removal of strainer dome
- Available in 3", 4", 5" and 6"

Aluminum/Copper Hercules

- Aluminum Hercules has a one piece spun aluminum body and cast aluminum clamping ring
- Copper Hercules is made of two parts: copper drain flange welded to copper drain stem pipe
- Available in 3", 4", 5" and 6" sizes



U-Flow Seal

Mechanical compression seal creates water-tight connection



U-Flow Screwdriver

Other U-Flow products also available

Test Plugs - 3" and 4"

- for plugging a drain before connection to plumbing

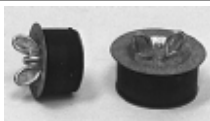

Fernco Coupling



Fernco Coupling with Reducer

Fernco Couplings

- for direct connection to drain leaders
- available in several sizes

Standard Metal Roof Deck

Light Zinc Coat Roof Deck 22 GA. Available in 36" x 96" panels. Custom lengths available by special order.

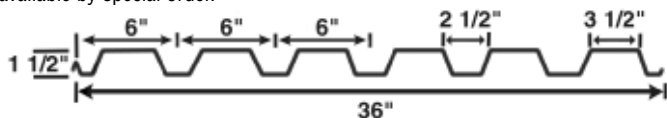

Lead Sheet

- comes in easy to handle roll
- 18" x 4' x 1/32"
- very malleable
- excellent for forming around pipes, etc.



O.G. Style Eavestrough and Accessories

Available in Galvanized, Copper and Pre-painted

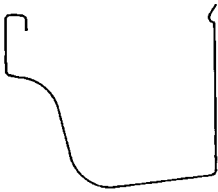

Eavestrough

4" (10" girth) and 5" (12" girth) available.
Stocked in 10' and 20' lengths in 28 gauge galvanized and 16 oz. copper.
Custom lengths and colours available.

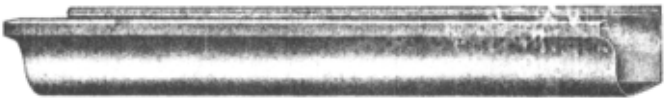

Inside Mitre



Outside Mitre



End Caps



Centre Drop



Round Outlets



Trough Tubes and Spikes

in a variety of sizes

SERVICE IS OUR SPECIALTY • SPAR-Marathon

Available in Galvanized, Copper and Pre-painted

“K” Style Eavestrough

10” girth “K” Style available in 10 ft and 20 ft lengths.



Corrugated Conductor Pipe

3” and 4” round corrugated Pipe



75° Corrugated Conductor Elbow

Square Corrugated Conductor Pipe

2” x 3” and 3” x 4” square pipe



Square Corrugated Elbow – Style “B”



3” Brick Pipe Hook



3” and 4” Wood Pipe Hook



Wire Strainers
3” and 4”



Square Corrugated Elbow – Style “A”



Muriatic Acid
1 litre and 4 litres



Soldering Irons
3 lb Pointed Copper
(Handle sold separately)



Soldering Paste
2 ounce and 1 pound



Sal Ammoniac
1 pound bars



Acid Brushes



50/50 Solder Bars
or 1 lb Wire

Also available: charcoal

SMART SCREEN™

The SMART Gutter Protection System

HEAVY DUTY Construction strengthens your gutters, giving added protection against the weight of snow and ice.

HASSLE-FREE installation fits easily over existing gutters and can be installed with basic tools. Convenient 6 foot length!

RECESSED FASTENERS provide a clean, virtually invisible installation.

ALL ALUMINUM Construction provides maximum durability.

SMART SCREEN™ does more than keep your gutters clear, it strengthens them while providing superior water dispersion.

OUTPERFORMS and **OUTLASTS** systems costing many times more.



Eavestrough Screen











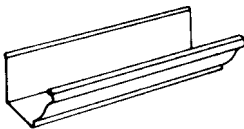

- easy clip on design
- keeps leaves and debris clear of eavestrough
- available in 3' lengths
- white or brown trim, copper, mill also available







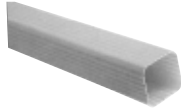



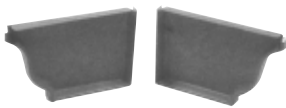

OAKVILLE, ON
(905) **825-0034**

LONDON, ON
(519) **668-3626**

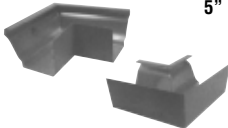
HAMILTON, ON
(905) **560-2858**

BARRIE, ON
(705) **792-6683**

 <p>5" Seamless Eavestrough Available in 10' and 20' Lengths</p>	
 <p>Mini Coils</p>	 <p>Small Square Elbow</p>
 <p>Trough Coil</p>	 <p>3" x 3" Large Square Elbow</p>
 <p>Small Square Downpipe</p>	 <p>2" x 3" A Elbow</p>
 <p>2" x 3" Downpipe</p>	 <p>2" x 3" B Elbow</p>
 <p>3" x 4" Downpipe</p>	 <p>3" x 4" A Elbow</p>
 <p>3" x 3" Large Square Downpipe</p>	 <p>3" x 4" B Elbow</p>

 <p>Small Square Outlet</p>	 <p>Large Square Outlet</p>
 <p>2" x 3" Outlet (Also available in oval)</p>	 <p>3" x 4" Oval Outlet</p>
 <p>5" End Cap</p>	 <p>Gutter Spikes</p>
 <p>5" Box Mitre</p>	 <p>Ferrules</p>
 <p>5" Quick-Screw Bracket</p>	 <p>5" Heavy Duty Bracket</p>
 <p>Pipe Strap</p>	 <p>3" - 4" Wire Strainer</p>



Industrial Steel Cladding

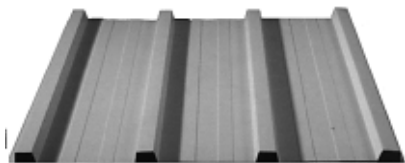

Exclusively designed for commercial applications, Commercial Rib is extremely versatile – enhance roofs, side walls, store fronts and awnings.

Especially recommended for wall or roof applications in either new construction or renovation projects.

On new structures, Industrial-Metro gives a sharp high-tech appearance; on older buildings or renovation projects, it updates the appearance yet harmonizes with existing designs.

This asymmetrical design features strong 1-1/2-inch deep ribs that are an attractive choice for a siding or roofing profile on commercial and industrial buildings.

Can be used as both roofing or siding on steel or wood structures on commercial or industrial buildings.

Corrugated 7/8" can be used as roofing or siding and is roll formed in lengths of up to 40 feet. This panel is available in widths covering 36" or 27-1/2".

Now available as a vital part of the insulated "sandwich wall system" supporting the insulation and sealing off the building from the inside.

Commercial Rib – Roof or Wall Profile

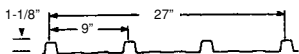

Universal Rib – Roof or Wall Profile

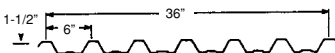

Industrial Metro Siding – Wall Profile

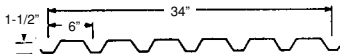

VEE-Rib – Roof or Wall Profile

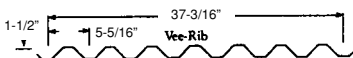

Utility Panel – Roof or Wall Profile

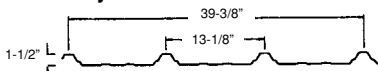

Corrugated 7/8" – Roof or Wall Profile

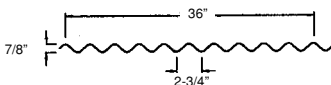

Supreme Interior Liner

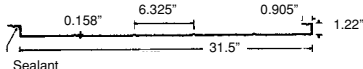

Lightweight Steel Cladding



Security Rib - Roof or Wall Profile

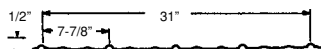

Our most enduring metal roofing and siding profile, Security Rib is ideally suited for agricultural, residential and small storage buildings.

Pocket Rib - Roof Profile

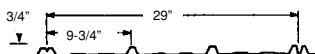

The industry's best roofing profile against leakage!! Combines the safety of double ribs with an anti-siphon pocket. Ideal for residential, agricultural, light commercial and industrial buildings.

Diamond Rib - Wall Profile

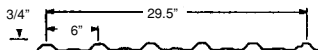

The industry's most versatile, light-weight steel siding profile. Consider Diamond Rib for commercial, agricultural, light industrial and even for some specialized residential construction.

Colonial Siding - Wall Profile

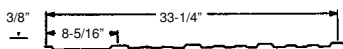

The economical "alternative" to regular residential cladding products. By imitating old-fashioned board and batten siding, Colonial adds an authentic rustic look to your home, garage or cottage.

Laurentian Rib - Wall Profile

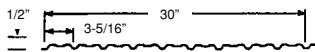

Resembling old-fashioned tongue and groove wood siding, Laurentian Rib beautifies and protects residential and light commercial properties.

Ameri-Cana Panel - Roof or Wall Profile

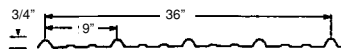

Adaptable to any environment, Ameri-Cana Panel is suitable for roofing or siding on any agricultural, residential, light commercial or light industrial building.

Heritage Series - Roof Profile

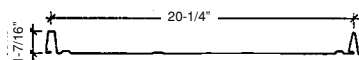

Heritage Series steel roof panels bring back the rich traditional style and appearance of standing seam roofs without the need of clips and a seamer when installing.

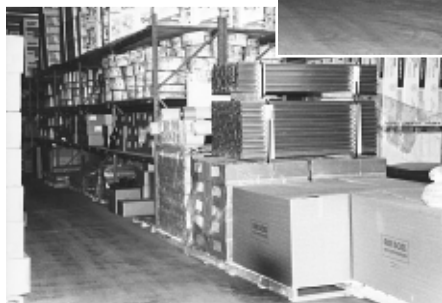

We have committed to extensive inventories to ensure that you have the products you want, when and where you want them, at the prices you need.

OAKVILLE, ON
(905) **825-0034**

LONDON, ON
(519) **668-3626**

HAMILTON, ON
(905) **560-2858**

BARRIE, ON
(705) **792-6683**